



For medium- and high voltage switchgear

compact fault annunciator

www.ees-online.de

info

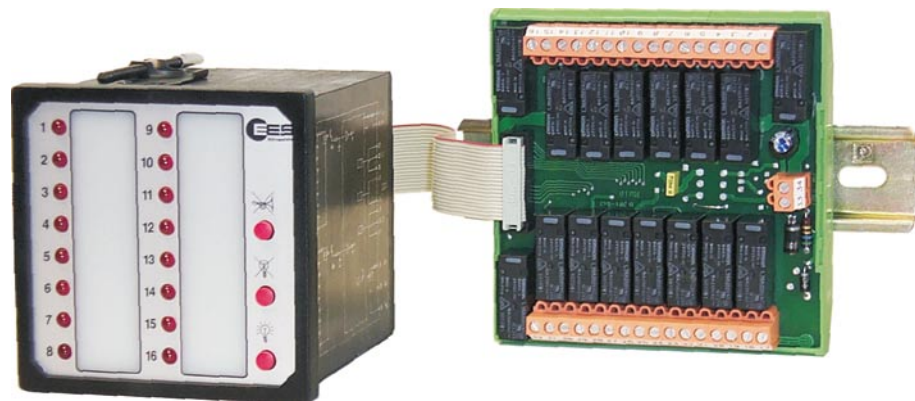

SSM 16-R

panel-mounted standard fault annunciator

16 alarms and external relay output module

Performance data:

- compact module for 16 alarms 24V ... 250V
- standard LED - colour red, other colours optional
- single- frequency flashing light
- 2 alarm priorities
- potential separation of all current circuits
- plug-in connecting terminals
- clear windows for slide-in labels

General system description

In control and monitoring systems, there is a frequent demand on a simple fault indicator to be used as universally as possible. The wiring efforts should be limited to a minimum; there is no space for additional controls.

The module **SSM 16-R** in a panel-mounted housing 96 x 96mm is a complete fault annunciator unit with integrated 5mm LED's, push buttons for lamp test, horn acknowledgement and lamp acknowledgement. Alarm voltage is potentially separated by opto-couplers from the supply voltage and every phase can be used as alarm voltage.

Note: Alarm no. 8 has a switch on delay of only 10ms (for example trip alarm)

The collective report is subdivided into 2 priorities; $\Sigma 1$: channel 1 ... 8 and $\Sigma 2$: channel 9 ... 16. In addition, a horn contact has monitoring function.

By use of the external relay module **RM 16** each alarm signal can be passed – for example - to a central control system. This relay module is connected by a ribbon cable with the basic annunciator **SSM 16-R** and can be snapped onto DIN-rail. Each relay-contact is wired to a screw terminal and standardly assembled in NO function. NC function of relays is available on request. If more than one relay contact is needed, the ribbon cable may be equipped with a second plug connector for connection of a further relay module. The relays are switched according to the alarm inputs.

The following functions are fixed, other functions on request.

- 1) Make-input principle for all alarms
- 2) No first-up alarm
- 3) Horn will be reactivated in case of following alarms
- 4) Collective report not inverted

Lamps and horn can be also acknowledged by means of internal or external push buttons. The wiring is made by plug-in terminals. The LED's can be labelled by slide-in strips - two rows with 21mm text length and 10mm height per channel.

Functional description

The input voltages are conducted by opto-couplers and resistance dividers to an electronic switching stage each. This ensures that interfering voltage below the response threshold (ripple) can not result in sounding horn or in flashing LED's. The LED's are directly controlled by the switching stage and supplied by the supply voltage to ensure the uniform brightness even for high variations of the input voltage.

Alarm sequence

Single-frequency fault annunciating „no first-up alarm“

The presence of a fault signal for longer than approximately 100ms (channel 8 only 10ms) causes the associated LED to start flashing, horn and collective report are triggered and the alarm is stored. All incoming alarms are indicated by a flashing LED. As soon as the acknowledgement buttons for horn and lamp are activated, the horn relay falls back and causes the horn to silence and the lamp changes from flashing to permanent light, if the alarm still exists; otherwise the LED turns off. The collective report turns off only after all individual fault signals have been acknowledged and eliminated.

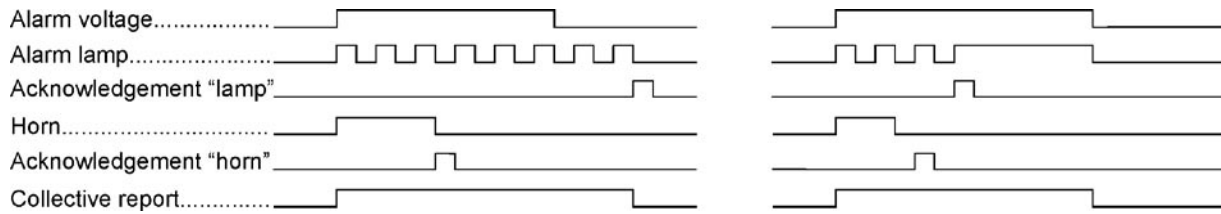

As standard, 6 versions are available for supply voltages of 24V, 48V, 60V, 110V, 125V and 220V. Other voltages on demand.

type	SSM 16-R/24V DC	SSM 16-R/48V DC	SSM 16-R/60V DC
Supply voltage	24V DC ± 20%	48 ... 110V DC -20 / +15%	48 ... 110V DC -20 / +15%
Power consumption	approx. 5W	approx. 8W	approx. 8W
Alarm voltage	19 ... 60V DC*	40 ... 72V DC*	48 ... 90V DC*
Response threshold	approx. 16V	approx. 38V	approx. 48V
Input current	approx. 4mA	approx. 2,5mA	approx. 2,5mA

type	SSM 16-R/110V DC	SSM 16-R/125V DC	SSM 16-R/220 V DC
Supply voltage	48... 110V DC -20 / +15%	125...220V DC - 10 / +15%	125 ... 230V DC -10 / +15%
Power consumption	approx. 8W	approx. 8W	approx. 8W
Alarm voltage	85 ... 145V DC*	85 ... 145V DC*	175 ... 250V DC*
Response threshold	approx. 72V	approx. 72V	approx. 170V
Input current	approx. 2mA	approx. 2mA	approx. 1,4mA

* Channel 1 ... 7 and 9 ... 16 are possible with AC. Channel 8 can only handle DC.

Switch on delay Alarm 1...7
and 9...16

approx. 100ms

Switch on delay Alarm 8

approx. 10ms

Surge input voltage

2,5kV acc. to IEC-Pub. 60 1,2µs/50µs

Load of relay contacts

24 ... 250V AC 2A; 110V DC 0,5A; 220V DC 0,3A

Flash frequency

approx. 1Hz

Mechanical data

Panel frame

96 x 96mm; approx. mounting depth 125mm

Mounting hole

91 x 91 ^{+0,5}mm

Mounting position

arbitrary

Weight

approx. 0,5kg

Ambient conditions

Ambient temperature

-20°C +60°C without condensation

Storage temperature

-20°C +70°C without condensation

Duty cycle

100%

Increase protection front side

IP40; IP50 with window door, IP65 with protection cover

Increase protection rear side

IP20

Terminals

nominal cross section 0,2 ... 2,5mm²

Humidity

max. 75% average annual temperature
(group F DIN 40040)

Immunity to interference

EMC-tested acc. to EN 61000-4-2,4,5

Available Options

- **BSV 1** labelling pattern (10 in a pack)
- **BSV-Soft** a disk with labelling pattern for WIN WORD Version 6.0
- **KSH1** protection cover
- **KST1** window door
- **tropical protected version**

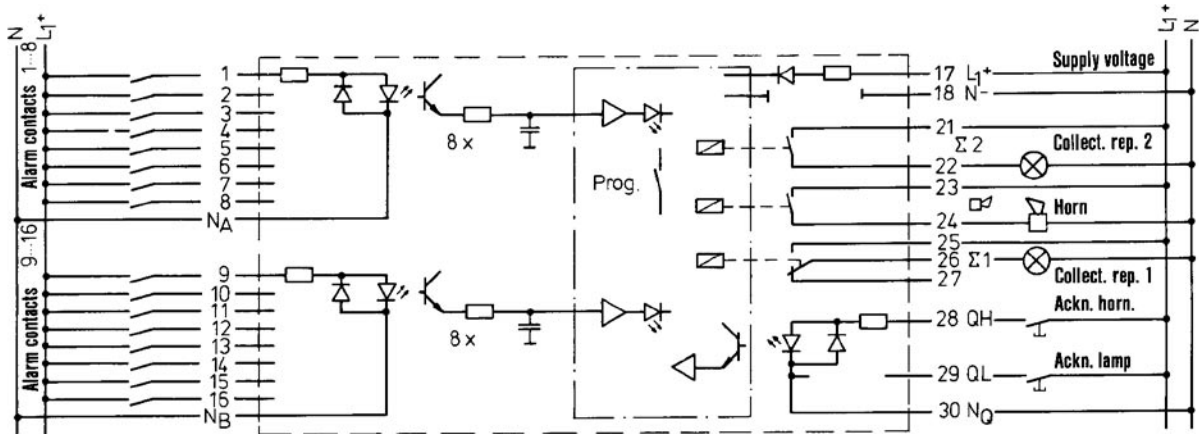

* ribbon cable connector to externa relay module 1,5m long

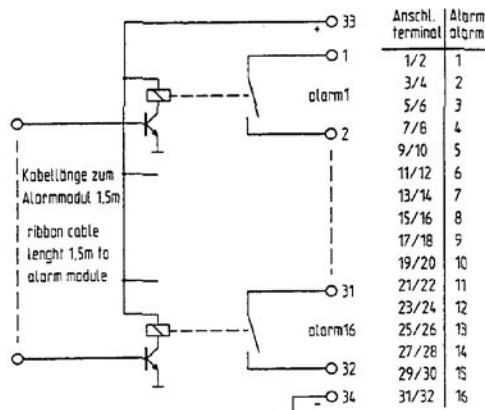
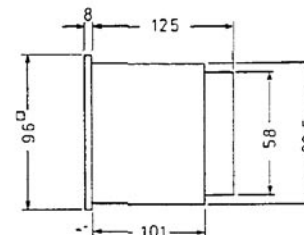
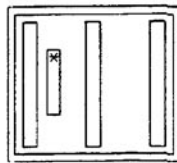

Option Öffner Kontakte optionally nc-contacts all works

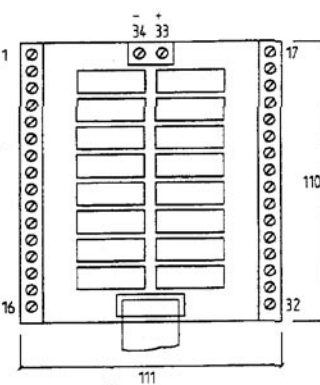

Externes Relaisausgangsmodul External relay-output module

Relay-module RM 16

dimension in mm

Subject to technical changes without prior notice.



HOTLINE
07191/182-235
-214



INTERNET
www.ees-online.de

EES **Elektra Elektronik GmbH & Co Störcontroller KG**
Hummelbühl 7-9 • D-71522 Backnang/Germany • P.O.Box 12 40 • D-71502 Backnang
Telephone: +49(0)7191/182-0 • Telefax: +49(0)7191/182-200 • e-mail: info@ees-online.de